



testo 830-T1 (0560 8311)
testo 830-T2 (0560 8312)

Bedienungsanleitung	de
Instruction manual	en
Mode d'emploi	fr
Manual de instrucciones	es
Manuale di istruzioni	it
Manual de instruções	pt
Руководство пользователя	ru
Handleiding	nl



1. General Information

Please read this document through carefully and familiarise yourself with the operation of the product before putting it to use. Keep this documentation to hand so that you can refer to it when necessary.

2. Product Description



Accessories

Name	Item no.
Water-tight immersion/penetration probe, -60 to +400°C / -76 to +752°F	0602 1293
Quick-reaction surface probe, -60 to +300°C / -76 to +572°F	0602 0393
Robust air probe, -60 to +400°C / -76 to +752°F	0602 1793
Leather protection sleeve	0516 8302
Emissivity adhesive tape $\epsilon = 0.95$	0554 0051

3. Safety Information



Avoid electrical hazards:

- ▶ Contact measurement: Do not measure on or near live parts.
- Infrared measurement: Please adhere to the required safe distance when measuring on live parts.



Preserving product safety/warranty claims:

- ▶ Operate the instrument properly and according to its intended purpose and within the parameters specified. Do not use force.
- ▶ Do not expose to electromagnetic radiation (e.g. microwaves, induction heating systems), static charge, heat or extreme fluctuations in temperature.
- ▶ Do not store together with solvents (e.g. acetone).
- ▶ Open the instrument only when this is expressly described in the documentation for maintenance purposes.



Laser radiation!

- ▶ Do not look into laser beam.



Ensure correct disposal:

- ▶ Dispose of defective rechargeable batteries and spent batteries at the collection points provided.
- ▶ Send the instrument directly to us at the end of its life cycle. We will ensure that it is disposed of in an environmentally friendly manner.

4. Intended Use

testo 830 is a compact infrared thermometer for the non-contact measurement of surface temperatures. Using testo 830-T2, it is possible to carry out additional contact measurements by attaching probes.



Not suitable for diagnostic measurements in the medical sector!

5. Technical Data

Feature	testo 830-T1	testo 830-T2
Parameter		°C/°F
Infrared measurement range	-30 to +400°C/-22 to +752°F	
Infrared resolution	0.1°C/0.1°F	
Infrared accuracy (at 23°C) +/- 1 digit	±1.5°C/2.7°F or 1.5% of reading (+0.1 to +400°C/+32 to +752°F) ¹ ; ±2°C/3.6°F or 2% of reading (-30 to 0°C/-22 to +31.9°F) ¹	
Emissivity	0.1 to 1.0 adjustable	
Infrared measurement rate	0.5s	
Temp. sensor	-	Thermocouple Type K (attachable)
Measurement range of temp sensor	-	-50 to +500°C/-58 to +932°F
Resolution of temp. sensor	-	0.1°C/0.1°F
Accuracy of temp. sensor (±1 digit)	-	±0.5°C/0.9°F+0.5% of reading at rated temperature 22°C/72°F
Measuring rate of temp. sensor	-	1.75s
Optics (90% value)	10:1 ²	12:1 ²
Laser type	1 x laser	2 x laser
Operating temperature	-20 to +50°C/-4 to +122°F	
Transport/Storage temperature	-40 to +70°C/-40 to +158°F	
Power supply	9V block battery	
Battery life	20 h	15 h
Housing	ABS	
Dimensions (LxHxB)	190 x 75 x 38 mm/7.5 x 3.0 x 1.5 in	
CE guideline	2004/108/EEC	
Warranty	2 years	
Laser		
Laser type	1 x laser	2 x laser
Power	< 1 mW	
Wavelength	645 to 660 nm	
Class	2	
Standard	DIN EN 60825-1:2001-11	

¹ the larger value applies

² +Opening diameter of the sensor (16mm/0.6 in)

6. Initial Operation

- ▶ Insert battery: See 9.1 Changing the battery.

7. Operation

7.1 Connecting probe (testo 830-T2 only)

- ▶ Connect temperature probe to probe socket. Observe +/-!

7.2 Switching on/off

- ▶ Switch on instrument: Press measurement button.
 - All display segments light up briefly. The instrument changes to the infrared mode (☀️ lights up).

The display light remains for 10 seconds every time a button is activated.

- ▶ Switch off instrument: Keep 🔽 pressed until display darkens.

The device switches off automatically after 1 min (IR measurement view) or 10 mins (contact measurement view, only testo 830-T2) without the button being pressed.

7.3 Measuring

! Observe information on infrared measurement (chapter 11) / contact measurement (chapter 12).

! With IR measurement, the min./max. values are reset by pressing the measurement button, and with contact measurement, this is done when the device is switched off or when you switch to the IR measurement view.

- The instrument is switched on.

Infrared measurement



- 1 Start measurement: Hold down measurement button.
- 2 Locate object to be measured using laser point.
 - testo 830-T1: laser marks the centre point of the measurement spot.
 - testo 830-T2: Laser marks the upper and lower end of the measurement spot.
- The current reading is shown (2 measurements per second)
- 3 End measurement: Release button.
 - **HOLD** lights up. The last measured value and min./max. value are saved until the next measurement.

▶ Switch between min., max. and recorded value: Press 🔺.



▶ Restart measurement: Press measurement button.

Contact measurement (testo 830-T2 only)









- Temperature probe was connected before the measuring instrument was switched on.
- 1 Position contact thermometer in/on the measurement object and activate the measurement: Press 🔽.
- The instrument changes to the contact measurement mode (→■ lights up). The current reading is shown.

- 2 End the measurement: Press  .
- **HOLD** lights up. The last measured value and min./max. value are saved until the next measurement.
- ▶ Switch between min., max. and recorded value: Press  .
- ▶ Restart measurement: Press  .
- ▶ Back to infrared measurement view: Press measurement button.

Setting the emissivity

- Instrument is in the infrared measurement mode.
- ! If no button is pressed for 3 s in the emissivity mode, the instrument switches to the infrared measurement mode.
- 1 Press  for 3 s.
- 2 Set emissivity: Press  or  .
- The instrument switches to the infrared measurement mode.

8. Settings

- Instrument is switched off.
- ! If no button is activated in the setting mode for 3 s, the instrument changes to the next mode.
- 1 Press  for 3 s.
- The device switches to settings mode.
- 2 Set lower alarm value (**↓ALARM**): Press  or  . Hold the button down to go forward quickly.
- 3 Set upper alarm value (**↑ALARM**): Press  or  . Hold the button down to go forward quickly.
- 4 Set alarm function **on / off**: Press  or  .
- 5 Select parameter (**°C / °F**) : Press  or  .
- The device returns to IR measurement view.
- ! The alarm function is only available for IR measurement. If the set alarm values are exceeded/not reached, a visual and acoustic alarm is output.

9. Service and Maintenance

9.1 Changing the battery



Instrument must be switched off!

- 1 Open battery compartment: Open up cover.
- 2 Remove used battery and insert new one. Observe +/- . The minus should be visible once the battery is inserted.
- 3 Close battery compartment: Close cover.

9.2 Clean instrument

Do not use abrasive cleaning agents or solutions.

- ▶ Clean the housing with a damp cloth (soap water).
- ▶ Carefully clean the lens with water or cotton buds dipped in water or medical alcohol.

10. Questions and Answers

Query	Possible causes	Possible solution
Display is no longer illuminated	- Low battery.	▶ Change battery.
 lights up.	- Battery empty.	▶ Change battery.
Instrument cannot be switched on	- Battery empty.	▶ Change battery.
Infrared measurement mode: - - - lights up.	- Readings outside measurement range.	-
Contact measurement mode: (testo 830-T2 only) - - - lights up.	- Readings outside measurement range. - No probe connected. - Probe damaged.	- ▶ Connect probe. ▶ Change probe.

If we have not answered your question, please contact your local distributor or Testo's Customer Service.

11. Information on infrared measurement

11.1 Measurement method

Infrared measurement is an optical measurement

- ▶ Keep lens clean.
- ▶ Do not measure with clouded lens.
- ▶ Keep measurement field (area between instrument and object being measured) free of interferences: no dust and dirt particles, no moisture (rain, steam) or gases.

Infrared measurement is a surface measurement

If there is dirt, dust, frost etc. on the surface, only the top layer will be measured, i.e. the dirt.

- ▶ In the case of shrinkwrapped foodstuffs, do not measure in air pockets.
- ▶ If values are critical, always subsequently measure using a contact thermometer. Particularly in the food sector, the core temperature should be measured with a penetration/immersion thermometer.

Adaptation time

- ▶ If the ambient temperature changes (change of location, e.g. inside/outside measurement) the instrument needs an adaptation time of 15 minutes for infrared measurement.

11.2 Emissivity

Materials have different emissivities, i.e. they emit different levels of electromagnetic radiation. The emissivity of testo 830 is set in the factory to 0.95. This is the ideal value for measuring non-metals (paper, ceramics, plaster, wood, paints and varnishes), plastics and food

Bright metals and metal oxides are only suited to a limited extent to infrared measurement on account of their low or nonuniform emissivity.

- ▶ Apply emissivity enhancing layers such as varnish or emission adhesive tape (Item no. 0554 0051) to the object being measured. If this is not possible, measure with the contact thermometer.

Emissivity table of the most important materials (typical values)

Material (Temperature)	ϵ	Material (Temperature)	ϵ
Aluminium, bright-rolled (170°C/338°F)	0.04	Heat sink, black anodised (50°C/122°F)	0.98
Cotton (20°C/68°F)	0.77	Copper, lightly tarnished (20°C/68°F)	0.04
Concrete (25°C/77°F)	0.93	Copper, oxidised (130°C/266°F)	0.76
Ice, smooth (0°C/32°F)	0.97	Plastics: PE, PP, PVC (20°C/68°F)	0.94
Iron, polished (20°C/68°F)	0.24	Brass, oxidised (200°C/392°F)	0.61
Iron with cast skin (100°C/212°F)	0.80	Paper (20°C/68°F)	0.97
Iron with rolled skin (20°C/68°F)	0.77	Porcelain (20°C/68°F)	0.92
Plaster (20°C/68°F)	0.90	Black paint, matt (80°C/176°F)	0.97
Glass (90°C/194°F)	0.94	Steel, heat-treated surface (200°C/392°F)	0.52
Rubber, hard (23°C/73°F)	0.94	Steel, oxidised (200°C/392°F)	0.79
Rubber, soft grey (23°C/73°F)	0.89	Clay, fired (70°C/158°F)	0.91
Wood (70°C/158°F)	0.94	Transformer paint (70°C/158°F)	0.94
Cork (20°C/68°F)	0.70	Brick, mortar, plaster (20°C/68°F)	0.93

11.3 Measurement spot, Distance

A specific spot is determined depending on the distance from the measuring instrument to the object being measured.

Measurement optics (Ratio Distance : Measurement spot)

testo 830-T1

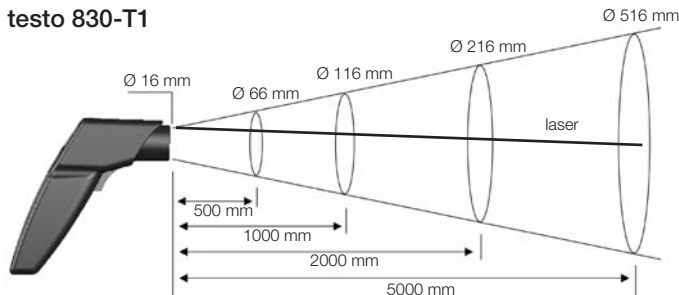

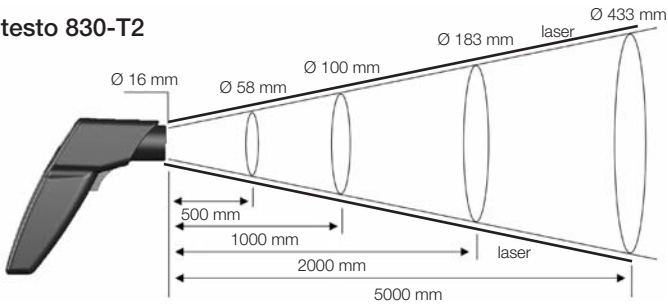
testo 830-T2

en

12. Information on contact measurement

- ▶ Observe minimum penetration depth in immersion/penetration probes: 10 x probe diameter
- ▶ Avoid applications in corrosive acids or bases.
- ▶ Do not use spring-loaded surface probes on sharp edges.